



# 2022

# NATIONAL CHAMPIONSHIPS



**JULY 5TH - 16TH, 2022**  
**CARDINAL SHOOTING CENTER | MARENGO, OHIO**

*“Brenda and I are proud to partner with the Scholastic Shooting Sports Foundation to support getting more kids involved in shooting sports today,” said Larry Potterfield, Founder and Chairman of the Board, MidwayUSA Office. “We strongly support initiatives like this because we believe we have an obligation to help change the future for the better.”*

THANK  
YOU!





# GET YOUR DEMO ON!

AT THE CZ-USA ULTIMATE DEMO TRAILER DURING THE 2022 SCTP NATIONAL CHAMPIONSHIP

## Demo Field #1



TRY OUT CZ'S NEW  
ALL-TERRAIN SERIES  
AS WELL AS MANY  
OTHER CZ SHOTGUNS!



@CZUSAFIELDSPORTS



# SCHOLASTIC SHOOTING SPORTS FOUNDATION



If you have questions after reading  
this program, please contact:  
[info@sssfonline.com](mailto:info@sssfonline.com)



## SSSF OFFICES

5931 Roft Road  
San Antonio, Texas 78253  
210-448-8946

[www.sssfonline.org](http://www.sssfonline.org)

## PRESIDENT'S LETTER

Greetings and welcome to your 2022 SSSF National Championships! The SSSF board of directors, staff and everyone involved in this wonderful event are glad to be back at the Cardinal Center for what is shaping up to be another record attendance year! At the time this program is going to press, the SCTP and SASP nationals have yet again set new records for attendance and event participation with a combined total of over 4,000 participating athletes and over 10,000 event entries. Thank YOU for your commitment in attending despite ever increasing costs in this inflationary year.

Our thanks also go out to all the sponsors, donors, and industry partners we have supporting our programs and foundation. We could not conduct such quality programs and championship events without all your support. Be sure to take some time to visit with all our sponsors and partners who have a presence at the event and thank them for their support. While on vendor row, be sure to stop into the SCTP/SASP store to get your official event shirts and other swag. The vendor shops at the Cardinal Center will be open and are sure to have everything you need and more!

In addition to all the competition shooting events we also have several special events to participate in. Opening ceremonies will be Wednesday night at the grandstands with the parade of teams, recognition of scholarship recipients and all scholastic team members plus some special guests.

There will be lots happening through the week and the best way to stay updated on news and other opportunities throughout the event is by joining our text messaging list. Simply text SSSFnationals to 877-617-6454 to sign up. I hope you enjoy your time at YOUR National Championships! We are glad you are here! Please be sure to share some of those special moments in your social media posts by tagging them with #SCTPNationals2022 and #SASPnationals2022.

Again, thank you for choosing to spend part of your summer with us in Ohio! We appreciate your participation in our programs!

Best of luck to all competitors – be safe and have fun!

Ben Berka



President and Executive Director

**SCHEELS**<sup>®</sup>  
EMPLOYEE OWNED

PROUD  
SPONSOR OF



YOUR  
**TRAP SHOOTING**  
GEAR HEADQUARTERS



**GOOD LUCK**  
TO ALL ATHLETES

CHECK US OUT ON [SCHEELS.COM/TRAPSHOOTING](https://www.scheels.com/trapshooting)

# 2022 SSSF NATIONALS TEXT UPDATES!

Sign up for our text messaging service to keep updated about current events, schedule changes, weather delays and other important news.

Simply text **SSSFnationals** to **877-617-6454** to opt in and you may opt out at any time. The service is free to use and will only be used for tournament information.

Standard messaging rates may apply.

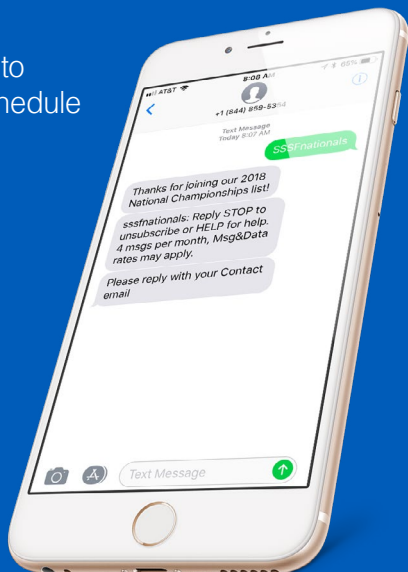

*Scan to start listening!*



The Scholastic Shooting Sports Foundation (SSSF) Rangetime podcast gives a once a recap on the news in the SCTP and SASP youth shooting sports programs. Additional interviews from athletes, coaches, sponsors, and others provides content you can't find anywhere else! Find us on your favorite listening platform, including Spotify, Apple, and Google Podcasts!

# SHOW YOUR COMMITMENT TO FIREARM SAFETY

## Pledge to Follow the Four Today

Shooting sports are great for learning sportsmanship, integrity and teamwork. But they're also a great opportunity to learn about firearm safety and responsible gun handling.

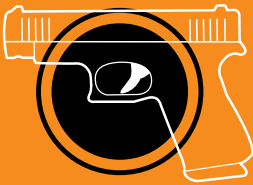
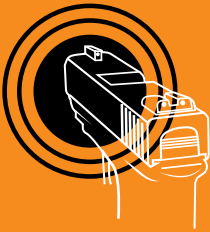
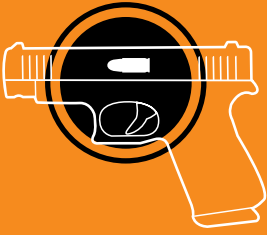

**Lead others by example and always remember these four key rules:**

### RULE 01

Treat all firearms as if they are loaded.

### RULE 02

Never point the muzzle at anything you are not willing to destroy.

### RULE 03

Keep your finger off the trigger until you're ready to fire.

### RULE 04

Always be sure of your target and what is beyond it.



**Ready to commit?**  
Scan to take the pledge  
and get your free digital  
GLOCK™ safety kit.





## TABLE OF CONTENTS

A Thank You to the Potterfields.....	2	SASP National Championship	
Director's Letter.....	5	Schedule of Events.....	46,47
Text Message Updates.....	7	SASP Match Information & Guidelines.....	48
Acknowledgements.....	10	Appeals Committee, Events, Awards.....	48
Staff List.....	13	SASP Event & TruGlo HOA Awards.....	48
SCTP National Team Championships		Camping.....	50
Schedule of Events.....	14,15	Ammunition.....	51
SCTP Tournament Info. & Guidelines.....	23	Golf Cart Rules.....	51
Appeals Committee, Events, Awards & Fees.....	23	Directions.....	51
Side Games.....	28	Additional Guidelines for SCTP & SASP.....	54
SCTP HOA Team Awards.....	33	SCTP Sponsors.....	58-59
SCTP Nationals Scholarships.....	36	SASP Sponsors.....	62-63
		SASP Stages.....	66,68,70,72
		2022 SSSF All-Scholastic Team.....	78-79
		Tribute to Jack Fishburn.....	89

## ADVERTISER INDEX

ATA.....	19	MidwayUSA.....	34,75
Baron Engraving.....	28	Mossberg.....	57,81
Bettinsoli.....	43	Next Level Training.....	16
Beretta.....	17,42	NobelSport Italia.....	56
Blackwing Shooting Center.....	84	Pardini USA.....	80
Birchwood Casey.....	69	Pilkington Competition.....	87
Boss LLC.....	53	Primary Arms Optics.....	73
Briley.....	71	Promatic.....	55
Browning.....	45,85	Randolph Engineering.....	20
Cardinal Shooting Center.....	85	Remington.....	65
Caesar Guerini.....	11	RUGER.....	38
Champion.....	41	SCHHEELS.....	6
CZ-USA.....	3,33,73	Shamrock Leathers.....	76
DSC Foundation.....	71	SIG SAUER.....	73
Ducks Unlimited.....	84	SKB.....	22
Fabarm.....	11	Sportsman's Den.....	31
FAIR.....	51	Steel Target Paint.....	19
Fiocchi.....	61	Swab-Its.....	73
GLOCK.....	8	TandemKross.....	74
The Great Outdoors Company.....	60	TETRA.....	27
GunBroker.com.....	85	Tipmann Arms.....	64
Guns Unlimited.....	86	Top Gun.....	29
Hayley Wilson Photography.....	39	TruGlo.....	77
HD Hunters Gold.....	60	Ultimate Shooting Accessories.....	32
Hodgdon Powder.....	30	Volquartsen.....	42
Junior Shooters.....	24	Walker's.....	12
Kolar.....	37	White Flyer.....	40
Mantis X.....	19	Winchester.....	44
Megalink.....	80		
MEC.....	26		

## ACKNOWLEDGEMENTS

5.11  
 Amateur Trapshooting Association  
 Baron Engraving  
 Beretta  
 Betsy Ross Arms  
 Bettinsoli USA  
 BKL Technologies  
 Blackwing Shooting Center  
 Bob Allen  
 BOSS, LLC  
 Bourgeois Fishing Charters  
 Briley  
 Brownells  
 Browning  
 BulkMunitions  
 Cabella's  
 Cardinal Center  
 Carson Caudill  
 Caesar Guerini  
 Cedron Farms  
 Champion Target  
 Christopher David Hodgdon  
 Clayshooting USA  
 Coast  
 Cotton Exchange - Wisconsin  
 Country Gentleman  
 Crown Awards  
 CZ-USA  
 D&S Phillips Foundation, Inc.  
 Dave Miller  
 Denis Karnosky  
 Dick Leeper  
 Dillon Precision  
 Douglas Koenig  
 DSC Foundation  
 Ducks Unlimited  
 Eagle Golf Carts  
 East Cape  
 Ed Fitzgerald  
 Eley Ammunition  
 Elite Shotguns  
 Exclusive Hunt Club  
 Fabbrica Armi Isidoro Rizzini  
 Federal Premium  
 Fine Designs  
 Fiocchi  
 Frogg Toggs  
 GLOCK  
 Gnosis Solutions  
 God's Country Outfitters  
 Grizzly Hearing Protection  
 GSM Outdoors  
 GT Targets  
 GunBroker.com  
 Guns Unlimited  
 Henry Rifles  
 Pardini USA  
 Hodgdon Powder  
 Hoppe's  
 Hunter's Blend Coffee  
 Hunters HD Gold  
 IFG/FAIR  
 Jack Fishburn  
 Joe Greve  
 John Richardson  
 Jon Warn  
 Joubert Pro Hunts - South Africa  
 Junior Shooters Magazine  
 Kemble duPont  
 Kids & Clays  
 Kolar Arms  
 Larry and Brenda Potterfield  
 Legacy Sports International  
 Louise Terry  
 Magpul  
 MantisX  
 MEC  
 Megalink  
 Metal Decor Studio  
 Michelle Toll  
 MidwayUSA Foundation  
 Monarch Trophy Studio  
 Mossberg  
 Mr. & Mrs. Christopher D. Hodgdon  
 National Christian Foundation  
 National Rifle Association  
 National Skeet Shooting Association  
 National Sporting Clays Association  
 National Wild Turkey Federation  
 Next Level Training  
 Norma Ammunition  
 Otis  
 Outfitters, Inc  
 Pardini USA  
 Paul Dandini  
 Pilkington Competition  
 Pilla  
 Primary Arms Optics  
 Project Child Safe  
 Promatic  
 Rain Rite  
 Randolph Engineering, Inc. / RE Ranger  
 Rick & Kris Leach  
 Robert L. Clausen  
 Rodney Spade  
 Rudy Project  
 Ruger  
 SCHEELS  
 Scott Linden Outdoors  
 Wing Shooting USA  
 Shamrock Leathers  
 SHIRTSandLOGOS  
 Shooting USA  
 SIG SAUER  
 SK Ammunition  
 SKB  
 Sporting Outdoors International  
 Sportsman's Den  
 Steel Target Paint  
 Stephanie Coffey  
 Swab-Its  
 TandemKross  
 TETRA  
 The Great Outdoors Company  
 Thomas Bub Edwards  
 Tilden Trophies  
 Tippman Arms  
 Tom and Amanda Wondrash  
 Top Gun Shooting Sports  
 Trapshooting USA  
 Trijicon  
 TriStar Sporting Arms  
 Tulsa Community Foundation  
 Ultimate Shooting Accessories  
 USA Shooting  
 Vista Outdoors  
 Volquartsen  
 Vortex Optics  
 Walker's Hearing Protection  
 Walther  
 White Flyer  
 Whitetails Unlimited, Inc.  
 Winchester  
 Wild Rose Bar & Grill - Todd Veeseer  
 William Marquardt  
 William Nordhausen  
 Worldwide Ltd.

# CAESAR GUERINI

## COMPETITION GUNS BUILT FOR FUTURE CHAMPIONS

At Caesar Guerini, we offer more competition shotguns designed for up-and-coming competitors than any other company. We focus on giving youth shooters the tools they need to be successful without having to take out a second mortgage. Come visit us at our booth and demo our guns to learn more about how Caesar Guerini helps young shooters excel at their sport.



SUMMIT TRAP COMPACT



SUMMIT SPORTING COMPACT

(410) 901-1131 [GUERINIUSA.COM](http://GUERINIUSA.COM)



**FABARM**  
100% MADE IN ITALY. SINCE 1900

## ONE SHOTGUN FOR MULTIPLE DISCIPLINES



**ELOS N2  
ALLSPORT**

**DEMOS  
AVAILABLE**

The **Elos N2 Allsport** is an incredibly versatile shotgun. It is designed for shooters who want one gun that can be configured for various styles and disciplines. Whether you shoot Sporting Clays, FITASC, Skeet or Trap – The Elos N2 Allsport has you covered. Stop by and demo one today and ask about all of the features that make this gun an outstanding value for **SCTP** shooters!

**410.901.1260**

**FABARMUSA.COM**

**4**LISTENING MODES  
UNIVERSAL

CLEAR VOICE

HI-FREQUENCY

POWER BOOST

RECHARGEABLE

# FIRE MAX DIGITAL MUFF

WALKER'S® INTRODUCES FIREMAX – THE PINNACLE IN ELECTRONIC SHOOTING MUFFS, THE ALL NEW FIREMAX IS THE RESULT OF OVER THREE DECADES OF EXPERIENCE IN INDUSTRY LEADING HEARING PROTECTION DEVELOPMENT. FIREMAX INCORPORATES WALKER'S LAUDED SOUND ACTIVATED COMPRESSION PROTECTION BUILT INTO A SLIM STREAMLINED DESIGN. THE DIGITAL PLATFORM INCLUDES FOUR SELECTABLE FREQUENCY MODES, CONTROLLED BY SILENT SOFT TOUCH DIGITAL BUTTONS AND POWERED BY A 2000mAh RECHARGEABLE LITHIUM BATTERY FOR OVER 200 HOURS OF PERFORMANCE PROTECTION.



- HI-PERFORMANCE DIGITAL CIRCUIT DELIVERS BLAZING FAST REACTION TIME ENSURING OPTIMUM PROTECTION
- GEL FILLED EAR PADS FOR COOLING AND COMFORT
- FULL DYNAMIC RANGE HD SPEAKERS
- TACTI-GRIP™ HEADBAND
- WEATHER RESISTANT - IP54 ANSI RATED



## FIREMAX WALKIE TALKIE

CUSTOM DESIGNED FOR SEAMLESS INTEGRATION SOLD SEPARATELY



## STAFF

### Scholastic Shooting Sports Foundation

Ben Berka – Executive Director  
 Terri Stanfill – Finance and Administrative Specialist  
 Tom Davis - Marketing and Communications Manager

### SCTP National Staff

Tom Wondrash – National Director	Hank Garvey – Regional Field Rep, Northeast Region
Amanda Wondrash – Administrative Coordinator	Bernie Till – Regional Field Rep, Southeast Region
April Carr – Administrative Assistant	Terri DeWitt – International Team Head Coach
Chet Tuinstra – Director of Development East	
Jeff Morrison - Director Of Development West	
Jason Anderson – Regional Field Rep, Lower Midwest Region	

### SASP National Staff

Rick Leach – National Director  
 Kelvin Walton – Director of Development -Action Shooting  
 James Hall – Director of Development -International  
 Bill Perkins - Regional Field Rep, Southwest Region  
 Kris Leach – Administrative Assistant

### Board of Directors

Ed Fitzgerald – Chairman	Louise Terry
Chris Hodgdon – Vice Chairman	Paul Pluff
Denis Karnosky– Finance/Budget Chairman	Tom Yost
Michelle Toll– Treasurer	Mark Wade
Nathan Boyd	Eliot Jardines
Thomas “Bub” Edwards	

### Tournament Directors

Tom Wondrash – SCTP  
 Rick Leach – SASP  
 Kelvin Walton – SASP

## SCTP INTERNATIONAL SCHEDULE OF EVENTS

- Monday, July 4 – Presented by Fiocchi //////////////////////////////////////  
10:00am – 5:00pm I-Skeet PET Training  
12:00pm – 5:00pm Check-In and Registration at International Fields
- Tuesday, July 5 – Presented by FAIR //////////////////////////////////////  
9:00am I-Skeet 75 targets competition  
12:00pm – 5:00pm Check-In and Registration at International Fields
- Wednesday, July 6 – Presented by RE Ranger //////////////////////////////////////  
9:00am – 5:00pm Check-In and Registration at International Fields  
9:00am I-Skeet 50 targets competition followed by Match Finals & Awards
- Thursday, July 7 – Presented by MEC //////////////////////////////////////  
9:00am – 5:00pm Check-In & Registration at International Fields  
10:00am – 5:00pm Bunker PET Training
- Friday, July 8 – Presented by Promatic //////////////////////////////////////  
8:00am – 5:00pm Check-In and Registration at International Fields  
9:00am Bunker Trap 50 targets competition
- Saturday, July 9 – Presented by Beretta //////////////////////////////////////  
8:00am – 5:00pm Check-In and Registration at International Fields  
9:00am Bunker Trap 50 targets competition
- Sunday, July 10 – Presented by Bettinsoli USA //////////////////////////////////////  
8:00am – 5:00pm Check-In and Registration at International Fields  
9:00am Bunker Trap 25 targets competition followed by match finals & awards

***\*True to the International disciplines, squads are chosen at random and squad times and flights will vary depending on total number of participants. This is an actual International event in all aspects, not a practice or try it type event. The SCTP International Team will be chosen from the finalists of this event.***

**Look for this sign  
posted in tents and  
on vendor doors!**



*These businesses proudly sponsor  
& support YOUR sport, PLEASE patronize  
them whenever possible!*

## SCTP SCHEDULE OF EVENTS

<b>Saturday, July 9 – Presented by Beretta</b> //	
8:00am	1st 100 of Saturday/Sunday Skeet, Trap Doubles, Handicap, Sporting Clays Rotation Open
9:00am – 5:00pm	Check-In and Registration
<b>Sunday, July 10 – Presented by Bettinsoli USA</b> //	
8:00am	2nd 100 of Saturday/Sunday Skeet, Trap Doubles, Handicap, Sporting Clays Rotation Open
9:00am – 5:00pm	Check-In & Registration
<b>Monday, July 11 – Presented by Kolar / Elite Shotguns</b> //	
8:00am	1st 100 of Monday/Tuesday Skeet, Trap Singles, Doubles, Handicap, Sporting Clays
8:00am – 5:00pm	Check-In and Registration
11:00am – 5:00pm	Games-Stores open
<b>Tuesday, July 12 – Presented by SKB</b> //	
8:00am	2nd 100 of Monday/Tuesday Skeet, Trap Singles, Doubles, Handicap, Sporting Clays
8:00am – 5:00pm	Check-In and Registration / Sporting Clays, Bunker Trap & Trap Practice Open
11:00am – 5:00pm	Games-Stores open
<b>Wednesday, July 13 – Presented by MidwayUSA Foundation: Jack Fishburn Day</b> //	
8:00am	1st 100 of Wednesday/Thursday Skeet, Trap Doubles, Singles, Handicap, Sporting Clays
8:00am – 4:00pm	Check-In and Registration Open / Sporting Clays & Trap Practice Open
9:00am	5-stand Charity Shoot Open – 100 Targets- Wednesday OR Thursday
11:00am – 5:00pm	Games-Stores open
5:30pm	All Industry Opening Ceremonies, States/Teams parade – Grandstands
7:00pm	Last Competitor Standing Competition on Trap Range
<b>Thursday, July 14 – Presented by CZ-USA</b> //	
8:00am	2nd 100 of Wednesday/Thursday Skeet, Trap Doubles, Singles, Handicap, Sporting Clays
8:00am – 5:00pm	Check-In and Registration Open / Sporting Clays & Trap Practice Open
9:00am	5-stand Charity Shoot Open – 100 Targets- Wednesday OR Thursday
11:00am – 5:00pm	Games-Stores open
6:30pm	Top Gun Team Shootout at Make-A-Break
<b>Friday, July 15 – Presented by SCHEELS</b> //	
8:00am	1st 100 of the Friday/Saturday Trap Singles Rotation Open
	Skeet Doubles
8:00am – 5:00pm	Check-In and Registration Open
9:00am	Sporting Clays Charity Shoot Open – 100 Targets- Friday OR Saturday
11:00am – 5:00pm	Games-Stores open
~6:00pm	Skeet & Sporting Clays Shoot Offs followed by awards at grandstands
	for Skeet, Sporting Clays, Handicap Trap, Doubles Trap, 5-Stand
<b>Saturday, July 16 – Presented by Winchester &amp; Browning</b> //	
8:00am – 12:00pm	Check-In and Registration Open
8:00am	2nd 100 of the Friday/Saturday Trap Singles Rotation Open
9:00am	Sporting Clays Charity Shoot Open – 100 Targets- Friday OR Saturday
11:00am – 5:00pm	Games-Stores open
~5:00pm	Skeet Doubles Bettinsoli Finals at Grandstands
~5:30pm	Make-A-Break Individuals Shootoff at Grandstands
~6:00pm	Team Shoot offs and 200 straight ties for Skeet and Sporting Clays
~7:00pm	Trap shootoffs followed by awards at grandstands
	for Skeet Doubles, Trap, all HOA awards

# IMPROVE YOUR PISTOLCRAFT



## **PRACTICE MAKES PERFECT**

Assessing the situation, acquiring a target, drawing from under a jacket, and taking the shot is a learned skill.



## **SITUATIONAL AWARENESS**

Assessing an environment takes training. Practice Situational awareness in the privacy of your own home.



## **KNOWLEDGE IS POWER**

Keep the kids safe from accidents firearm safety. The SIRT is a perfect educational tool.



## **SHARPEN YOUR SKILLS**

Train like a professional. SIRTs are designed and rigorously tested by one of the world's best shooters.



## **RESPONSIBILITY. ACCOUNTABILITY. SAFETY.**

A SIRT gives you and your loved ones the opportunity to train and make mistakes without repercussion.



## **FOR THE BEGINNER**

Carrying a weapon can be awkward. A SIRT is perfect if you're new to carrying and trying get comfortable.

## WHICH SIRT FITS YOU?



107



110



POCKET PISTOL



SIRT 20



SIRT 20C



More info at:  
[www.nextleveltraining.com](http://www.nextleveltraining.com)





A400  
**Xcel**  
SPORTING



**REDESIGNED RECEIVER**

AQUATECH SHIELD &  
ENLARGED CONTROLS

**BLINK GAS  
OPERATED SYSTEM**

36% FASTER FOLLOW-UP SHOTS

**STEELIUM OBHP**

STUNNING BARREL  
ACCURACY

**THE FASTEST, LOWEST-RECOIL CLAY BUSTER.**  
**BERETTA A400 XCEL SPORTING**

Built on the revolutionary A400 action, the newest iteration of the Beretta A400 Xcel Sporting features enlarged controls, the innovative Blink gas operating system for 36% faster follow-up shots, and Beretta's Kick-Off recoil reduction system for enhanced stability, comfort, and control for faster target acquisition.

#1CHOICEOFCHAMPIONS  
[INFO.BERETTA.COM/A400-XCEL](http://INFO.BERETTA.COM/A400-XCEL)



# Coach Certification, Modernized.

**Affordable**  
**Online-based**  
**Mobile-friendly**  
**Accessible 24/7/365**

**Sign up today at [www.shootingsports-ed.com](http://www.shootingsports-ed.com)**



# BEST WISHES FROM THE ATA



**TO ALL THE SCTP SHOOTERS  
AND TEAMS AT NATIONALS!**

**July 5-16th, 2022**

**CARDINAL SHOOTING CENTER • MARENGO, OH**



Amateur Trapshooting Association

AIM Youth Program

1105 East Broadway

P.O. Box 519

Sparta, IL 62286



[aim4ata.com](http://aim4ata.com)  
[aim@shootata.com](mailto:aim@shootata.com)  
618-449-2224

# SHOOT STEEL?



## STEEL TARGET PAINT



**ONE SHOT COVERS THE SPOT!**

**RANGESTORE.NET**

**1.888.488.1114**



**MANTIS**

## IMPROVE WITH EVERY SHOT.



# **KIM RHODE**

**6X OLYMPIC MEDALIST &  
33-TIME WORLD CUP MEDALIST**



**BUILT FOR THOSE WHO DEMAND THE BEST.**



**EDGE**



**FALCON PRO**

**R E RANGER**  
PERFORMANCE EYEWEAR

[WWW.RERANGER.COM](http://WWW.RERANGER.COM)

Visit one of our authorized dealers on site at the SCTP Nationals or the SCTP store for details.

## PIZZA & SODA PARTY

Thursday | 5:30pm – 7:00pm | by the CEB  
*Free pizza and soda while supplies last!*

Complements of:



## COLLEGE RECRUITING MEET & GREET

Friday | 9:00am – 4:00pm

at the "Hitters Building" next to the campground office!

Meet colleges with shooting programs  
and learn about shooting scholarship opportunities!

## TOP GUN CHALLENGE

Athletes competing in the Top Gun Challenge will shoot Trap, Skeet, Sporting Clays, Iron sight pistol (Rimfire or Centerfire), fastest rifle time, and 1911 with their scores from each event being compiled to calculate the winners.

# SKB

COMPETITION GUNS DESIGNED TO FIT YOU

## 90TSS



## CENTURY III



## RS300



For a current catalog go to  
[www.skshotguns.com](http://www.skshotguns.com)

## SCTP TOURNAMENT INFORMATION & GUIDELINES

### Practice:

#### Skeet Practice/Location/Price

Friday, July 8th – Sporting Clays Building  
 Open: 12:00pm                      Close: 5:00pm                      \$7 per round

#### Sporting Clays Practice/Location/Price

Saturday, July 9th – Tuesday, July 12th – Sporting Clays Building  
 Open: 8:00am                      Close: Dusk                      \$0.45 per target

#### Trap Practice/Location/Price

Saturday, July 9th – Tuesday, July 12th  
 Practice fields in front of grandstands  
 Open: 8:00am                      Close: Dusk  
 \$7.00 per round

Anyone wishing to practice Skeet or Trap on days that are not available at the Cardinal Center, can do so at the Black Wing Shooting facility, our official practice range. Information available at registration and sign up!

**Adult/Coach supervision required to purchase practice rounds and while shooting.**

**\*\*Drivers License is required to purchase practice keys. License will be held on file until practice key is returned.**

### Registration:

Head Coaches must check in at the Central Events Building, verify their team entry and squadding information, and pick up their Shoot Packets in person. All coaches will be required to sign off on their team's squadding, verifying that all squads and divisions are correct! Squads with mixed division athletes will be placed in the Open division. However, they must be complete (full) squads. Team and athlete event registration fees may be refunded through July 1st.

### Divisions and Categories:

Rookie — 5th Grade and Under

Intermediate Division / Entry — 6th to 8th Grade (First Year Competing as Intermediate)

Intermediate Division / Advanced — 7th and 8th Grade

Senior Division / Junior Varsity — 9th to 12th Grade (First Year Competing in Senior Division)

Senior Division / Varsity — 10th to 12th Grade

Open Division — Includes any combination of division athletes listed above. Open division does NOT include college-aged athletes.

### Collegiate

Athletes must have participated in an accredited SCTP College Program in 2021/2022 College Division will include ALL Collegiate and College Open squads this year.

SCTP will co-host a college tournament, October 5-9, 2022 at the Cardinal Center in Marengo, OH. This is open to all SCTP-registered college teams and athletes. Four divisions (to include two-year colleges) eligible for trophies, medals, and lots of fun!

### Adult Volunteers / Coaches

Adult Volunteers Registered with the SSSF/ SCTP

### Note:

Shoot times will be strictly enforced. Please do not waste time in between rounds, and NO coaching is allowed during or between rounds.

# JUNIOR SHOOTERS Magazine, STP & SASP

## Want your article!



## You could be in the next issue!

### Caledon Shotguns

For Kids

for the junior shooters out there and hope that I can continue to help promote shooting for the future. About six months ago I was given a pair of FAUST Caledon Over and Under (O/U) shotguns to try out - a 12-gauge and a Youth Model 20 gauge. I have since shot both many times and have really enjoyed doing so. The standard 12-gauge model features a 34 1/2" length of pull, automatic ejection, magnetic lock, and a single slide-action. The highest quality Turkish walnut is meticulously shaped, oiled, and hand polished to perfection. All models are offered in a 30" 28" or 26" barrel. The 12-gauge model weighs 7.25 pounds, while the 20-gauge weighs a modest 5.5 pounds. The Caledon performs well on sporting clays courses and carries well in the field. Many classic and timeless qualities make the Caledon unique among others in the field. The Youth Caledon has a barrel length of 25" x 12-1/2" length of pull and weighs only 5.5 lbs.

In the fall, I used both shotguns for hunting a variety of

hush and very steep. The birds like it where they think they are safe from hunters, which is many miles away from easy access. I used the 12-gauge and absolutely loved it! It was great for the difficult terrain. When you hike all day long and use all your energy to get to where you want to be (which is on top of the bird), you want your gun to perform flawlessly. The FAUST passed with flying colors.

**Ease of assembly.** The two FAUSTs were a snap to put together and came apart easily. Both had a very tight action. A tight action is important if you want your gun to last a long time, which these guns will.

**How it felt in my hands.** The guns felt great in my hands, and I really enjoyed shooting them both. The 12-gauge fit me perfectly and shot right where I wanted it to. It was really smooth to shoot and easy to swing at a moving bird or target. The barrel was just long enough so that you wouldn't miss something



that short enough that it could be swung around with any type of fast-moving object. The weight and balance were just what I needed. It was fun to make it count. The 20-gauge was also fun to shoot. It was just what I needed for that difficult terrain in other ways. It was lightweight and easy to shoot fast-moving birds because of this. I had a blast shooting both guns, and both felt great.

**Sights.** Each gun had a large brass bead at the end of its top barrel which was great. You could see birds and targets with great ease. The field of vision was enough that you could see where you were shooting and the target at the same time. I would not change the sight picture at all.

**Recall.** The recoil was noticeable but manageable. Both light target loads and heavy game loads were fine to shoot through the gun, and with the interchangeable choke tubes, you could adjust the pattern of the gun if you wanted to.

**Safety.** The guns had a safety on the top of the receiver, which was a much better safety as you have to turn it off every time you load the gun. This is great for bird hunting, which are what these guns are really made for, but not so much for shooting clay targets. The safety was easy to get to and turn off when it was time to shoot.

These guns were great and I would not change anything on either of them. They were awesome in every aspect, and I had a blast trying them out!

Thanks again, Junior Shooters, for allowing me to write this article for you.

#### CAPTIONS

1. FAUST's Caledon shotguns have light actions and are available in a Youth Model (top shotgun) as well as adult sized.  
2. The forearm clips in (they're engraved) and operates smoothly.  
3. The engraving on the left side of the receiver adds a nice touch of elegance to a very functional hunting shotgun.  
4. Philip with his dog and the Caledon 12-gauge out hunting pheasant.

5. Top view of the receiver shows the beautiful engraving and the clear metal-to-wood fit.  
6. The bottom of the receiver and trigger guard are exquisitely engraved.



This could be your article!

upland birds and had great success with both of them. Our day of pheasant hunting was very successful. The day that day with our first shot. The day was both fun and successful. So much recoil making it easy to shoot. The day was not cheap, but if you buy the right one, it never decrease in value and will

Another great aspect of these guns is the sensitivity. You could use them for almost anything. From the clay discipline (sporting clays, skeet, trap) to upland game, even to waterfowl, they are an all around good gun. I took the 20-gauge hunting many times for small and doves and loved using it. Both guns were so beautiful and at the same time rugged and reliable. The pleasure of regaining for a shotgun is a cherished hunting. It is probably the most challenging form of bird hunting, but also the most rewarding. Clucker country is

www.juniorshooters.net

www.faust-usa.com

Volume 9 Summer 2011

33

Call 208-629-8967 or email editor@juniorshooters.net

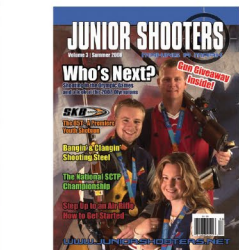
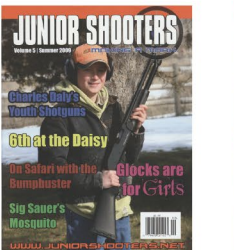



## APPEALS COMMITTEES

### TRAP

Wayne Rasmussen – WI  
 Roger Beardsley – PA  
 Rob Jones - WI  
 Jordan Hintz - MI  
 Rob Kinsella - OH  
 Tina Marshall – PA

### SPORTING CLAYS

Rob Conrad - WI  
 Jason Anderson – TX  
 Bernie Till – SC  
 Craig Peer – GA  
 Paul Wojtaszek - PA  
 James Harrod – FL

### SKEET

Rob Conrad - WI  
 Rob Jones - WI  
 James Harrod – FL  
 Bill Saylor – MI  
 Paul Wojtaszek - PA  
 Ida Brown - MI

## SCTP EVENTS AND AWARDS

Main Event Squad (Trap, Skeet & Sporting Clays)

Team Championships/Squad Awards – Division/Category 1st – 5th

(total targets broken by squad will be the winning squad)

Includes Squad "Open Division" awards 1st – 5th

Individual Awards (Trap, Skeet, Sporting Clays, HOA & Bunker Awards)

Individual Men – Division/Category 1st – 5th

Individual Ladies – Division/Category 1st – 5th

Concurrent Events (Trap, Skeet & Sporting Clays)

Scholastic High School Division 1st – 5th

PLEASE NOTE: The concurrent "High School Division Awards" (and HOA for HIGH SCHOOL Division Awards) will be determined by "TEAM SCORING" and not squad scoring this year.

Team scoring will be comprised of the top 5 scores in the Senior Division (Varsity & JV combined) for Trap, top 3 for Skeet and top 3 for Sporting Clays.

This is to reflect the true High School "Team" mentality for this division.

MAIN EVENT awards (and HOA) will be done as usual, by squad scoring!

## CONCURRENT EVENTS & NEW EVENTS

Will include 1st – 3rd place Squad Plaques/Medals and Individual 1st – 3rd place Boys' and Girls' divisions

### Handicap Trap

Rookie Squads shoot at 19 Yard

Intermediate Squads shoot at 21 Yard

Senior Division Squads shoot at 25 Yard (all college squads will also shoot from here)

Open Division Squads will ALL shoot at the furthest squadded athlete on that squad

NEW AWARD DIVISION - "Team Awards"

Senior Division (Varsity/JV) and Intermediate Division (Rookie/IE/IA)

Top 5 athletes in each combined division will be used for this

## TARGET FEES

Skeet Doubles – 100 targets- \$55 per shooter

Handicap Trap – 200 targets- \$100 per shooter

Trap Doubles – 200 targets- \$100 per shooter

Trap – 200 targets- \$100 per shooter\* (includes ATA fees)

Skeet – 200 targets- \$100 per shooter\* (includes NSSA fees)

Sporting Clays – 200 targets- \$130 per shooter\* (includes NSCA fees)

Coach/Volunteer Competition – 50 targets- Make-a-Break- \$30 per shooter

Bunker Trap- 125 targets- \$120 per shooter

International Skeet- 125 targets - \$115 per shooter

5 stand - 100 targets - \$50 per shooter



OUTDOORS



FROM THE RELOADING  
BENCH TO THE FIELD,  
MEC OUTDOORS IS  
WITH YOU.



AMERICAN MADE FOR OVER 65 YEARS

---

800-797-4632 | [mecoutdoors.com](http://mecoutdoors.com)  
#mecoutdoors

©2021 Mayville Engineering Company, Inc. All Rights Reserved

# TETRA

HEARING™



HEARING  
PROTECTION  
*PERFECTION*

LEARN MORE

[WWW.TETRAHEARING.COM](http://WWW.TETRAHEARING.COM)

## SIDE GAMES / ACTIVITY DETAILS

“Make A Break” (Two shooters)

\$10 per shooter

DAILY ammunition prizes as well as awards for Top Lady and Top Guy. The overall winner will walk away with a brand new firearm TBD! Top daily team winners and individual winners will shoot off on Saturday at 2:30pm for prizes.

“Shoot The Flurry”

\$5 entry fee. Loads of fun!

Adults can play the games but are not eligible to receive the prizes.



# Baron Engraving

*Designing  
Lasting  
Value*



BaronEngraving.com

# METAL DÉCOR STUDIOS

Visit [metaldecorstudios.com](http://metaldecorstudios.com) and use code “SSSF” at checkout.



Special Thank you  
to the Wild Rose Pub & Grill

# TOP GUN

## SHOOTING SPORTS



## TOP GUN TEAM SHOOT OUT 2022

The **TOP GUN TEAM SHOOT OUT** will be held  
**Thursday, July 14th at 6:30 PM**

At that time the top 4 qualifying teams will go  
head-to-head in a bracketed best of 3 game format.

The winning team will receive:

- 10 flats of Federal Ammunition -
- Browning "The Best There Is" range gear -
- Make-A-Break Championship Trophy -
- The chance to have your team's name and logo featured in the movie ***One Last Shot*** -

Please go to the following sites for details  
on how YOUR team can participate!

Instagram: [officialmakeabreak](https://www.instagram.com/officialmakeabreak)

Facebook: [Make-A-Break](https://www.facebook.com/Make-A-Break)

Website: [makeabreak.com](https://www.makeabreak.com)

Make-A-Break is a game by

 CLAY SPORT International



**IT'S ALREADY IN YOUR BLOOD. DON'T LET IT GET IN YOUR HEAD.**

Trust Hodgdon® shotgun powders.



913-362-9455 • [www.hodgdon.com](http://www.hodgdon.com)

HUNT.SHOOT.FISH.LIVE.



# SPORTSMAN'S DEN

SEE YOU AT THE DEN!

201 N. Gamble St. ■ Shelby, OH 44875  
SPORTSMANSDEN.COM ■ 419-347-3007



## LOCATED IN BUILDING A - UNIT 12

WE STRIVE TO HAVE THE LOWEST PRICES ON ALL AMMO AND RELOADING SUPPLIES AT THE SHOOT!

SHELLS, RELOADING SUPPLIES,  
SHOOTING ACCESSORIES



PLUS!!



## SPECIAL PRICES ON ALL GUNS!

**BROWNING** SPORTSMAN'S DEN EXCLUSIVE



TriStar

12GA., 32" and 34" w/Adjustable Rib

### BT-99 AR

# \$100<sup>00</sup> OFF





ULTIMATE SHOOTING  
ACCESSORIES

&

**CASTELLANI**

PROUD SPONSORS FOR THE  
SCTP NATIONAL TEAM



SCAN ME

**WE SPECIALIZE IN TEAM VESTS**

**VISIT OUR BOOTH**

**ASK ABOUT TEAM GLASSES  
OR CONTACT US FOR DETAILS**



[sales@ultimateshootingaccessories.com](mailto:sales@ultimateshootingaccessories.com)

(312) 622-2020

[www.ULTIMATESHOOTINGACCESSORIES.com](http://www.ULTIMATESHOOTINGACCESSORIES.com)



## SCTP HOA TEAM AWARDS

Main Event 1st – 5th

Main event HOA determined by a team's top trap squad, top skeet squad, top sporting clays squad

High School 1st – 5th

High School HOA determined by team's top 5 trap scores, top 3 skeet scores, top 3 sporting clays scores (Senior Division only)

\*High School Team – Senior Division only.



A gift to your favorite youth shooting program, through MidwayUSA Foundation, always goes further with our Matching Program.

**\$500 → \$1,050**

**\$1,000 → \$2,100**

**\$2,500 → \$5,250**

**AVERAGE DONATION MATCH IN 2021  
\$1.10 PER DOLLAR**



**SCAN - SEARCH - GIVE  
MIDWAYUSAFUNDATION.ORG**

# MAKE A DIFFERENCE, KEEP THEM ON THE RANGE!



To begin your support of youth shooting sports, visit  
**[www.sssfonline.org/donate](http://www.sssfonline.org/donate)**

- Simple Donations
- Scholarship Funds
- Supporting Memberships
- Memorial and Legacy Donations
- Amazon Smile Shopping Donations



*Scan to start your support today!*



# SCTP NATIONALS SCHOLARSHIPS

Register online (link below) **prior** to the 2022 SCTP National Championships being held from July 5th – 16th.

---



## 200 Target Trap event

Browning Scholarship of \$6,000 to the Top Registered Athlete shooting a Browning Shotgun for the 200 Target Trap Event at SCTP Nationals!



## 200 Target Sporting Clays Event

The highest Sporting Clays score shot with a CZ-USA Shotgun will win one of the CZ 1012 shotguns used in the Guinness World Record shoot led by “Clay Killer” Dave Miller! Dave will also personally sign this shotgun prior to awarding it to the winner!



## 200 Target Skeet Event

The top score shot using a Beretta Shotgun will win this brand new for 2022, Beretta Ultraleggero Shotgun! Compliments of Beretta and the SCTP!

**BEGIN REGISTRATION HERE**

# THE MOST EXTENSIVE LINEUP OF TRAP GUNS AVAILABLE. . .



- POI's from 60% to 140%
- Fixed or Adjustable Rib Configurations
- Right and Left Hand Stocks Available
- Light Weight Barrels
- Factory Release Triggers

For more information contact **KOLAR**  
or one of our regional distributors.

- Elite Shotguns  
[dan@elite-shotguns.com](mailto:dan@elite-shotguns.com)
- Elite Shotguns  
[elite@elite-shotguns.com](mailto:elite@elite-shotguns.com)
- Elite Shotguns Mobile Showroom  
[aaron@elite-shotguns.com](mailto:aaron@elite-shotguns.com)
- Gamemasters  
<https://www.gamemastersoutdoors.com>
- Michigan Shooting Centers, LLC  
[www.mishoot.com](http://www.mishoot.com)
- Paxton Arms  
[www.paxtonarms.com](http://www.paxtonarms.com)



**Proudly Made  
in the U.S.A.**

[WWW.KOLARARMS.COM](http://WWW.KOLARARMS.COM)

1925 ROOSEVELT AVE.

RACINE, WI 53406

262-554-0800



# RUGER

ARMS MAKERS FOR RESPONSIBLE CITIZENS®

RUGER PROUDLY SUPPORTS THE  
**SCHOLASTIC SHOOTING SPORTS FOUNDATION**

 [RUGER.COM](http://RUGER.COM)



# Official Nationals Event Photography by Hayley Wilson Photography





# BRING YOUR **A** GAME

WE'LL SECOND THAT... **AA** TARGETS

Whether it is Trap, Skeet or Sporting targets, we ensure every target is manufactured in the U.S.A. and meets all standards and weight specifications of the ATA, NSSA and NSCA.

Official Target of the ATA, AIM, SCTP, Grand American World Trapshooting Championships, World Skeet Championships, National Sporting Clays Championship and NSCA Championship Tour.



**WHITE**  **FLYER**®

[www.whiteflyer.com](http://www.whiteflyer.com)





# UNRIVALED AUDIO PROCESSING ALL DAY COMFORT



## VANQUISH™ PRO ELITE

ELECTRONIC HEARING PROTECTION

- Ultra-fast reaction time of less than 1 millisecond
- First hearing protection in shooting sports that offers Active Noise Cancellation
- Omni-directional microphones, HD speakers and available with Bluetooth®



SEE ALL VANQUISH MODELS AND COLORS AT [CHAMPIONTARGET.COM](http://CHAMPIONTARGET.COM)



**BERETTA**  
500 YEARS. ONE PASSION.

# SHOOT STRAIGHT. STAY SAFE.

## BERETTA SHOOTING PROTECTION

Check out our collection of shooting glasses and hearing protection.

SAVE 15% ON  
SAFETY GEAR +  
FREE SHIPPING

USE CODE  
SASP15

[BERETTA.COM](http://BERETTA.COM)

**JJ RACAZA**

INTERNATIONAL PISTOL SHOOTER

*Made in Carroll, Iowa*  
ESTD - 1974

## WORLD'S FINEST RIMFIRE RIFLES AND PISTOLS



Precision-built and accuracy guaranteed.  
Now there's no excuse to miss.

[VOLQUARTSEN.COM](http://VOLQUARTSEN.COM)



**Bettinsoli**  
U S A



## *Competition*

**GRAND PRIX DELUXE**

## *Field*

**DIAMOND DELUXE**

The main components of each gun are all made from solid forgings, meaning that the material fibers are not cut in any way by tools, therefore the resistance of the material remains intact for the absorption of the shot explosions.





the **LEADER** in  
**SHOOTING**  
**SPORTS**

**F**or nearly six decades, Winchester® AA® Target loads have been the industry standard used by the most demanding competitors. This shell has always utilized the best components made right here in the United States by American workers for American shooters. Featuring the best 6% Antimony shot available to competitors, the Winchester AA commands the best in performance and consistency. AA target loads have won your local shooting league, The Grand American, The NSCA National Championship, The World English, the World FITASC and the Olympic Gold Medal ... multiple times.



**HARD HITTING**  
**6% ANTIMONY SHOT**

+ Premium shot for the most demanding targets and competitions

**QUALITY COMPONENTS**

- + Legendary AA® Collapsible dual-hinged wad reduces felt recoil
- + Best-in-class powder and primers provide reliability shot after shot
- + High strength hull for consistent reloads



*Citori.*

CITORI GRAN LIGHTNING

CITORI WHITE LIGHTNING

CITORI FEATHER LIGHTNING

**BROWNING®**

SASP INTERNATIONAL SCHEDULE OF EVENTS

Thursday, July 7 – Presented by Megalink & Pilkington

9:00am, 11:00am, & 2:00PM	10 Meter Air Rifle/Pistol
9:00am	25 Meter Sport Pistol

Friday, July 8 – Presented by Pardini USA & Mantis

9:00am, 11:00am, & 2:00PM	10 Meter Air Rifle/Pistol
9:00am	25 Meter Sport Pistol

Saturday, July 9 – Presented by Walker's

9:00am, 11:00am, & 2:00PM	10 Meter Air Rifle/Pistol
9:00am	25 Meter Sport Pistol

Sunday, July 10 – Presented by Tippmann Arms

9:00am, 11:00am, & 2:00PM	10 Meter Air Rifle/Pistol
9:00am	25 Meter Sport Pistol
7:00pm	Awards

SASP ACTION SHOOTING SCHEDULE OF EVENTS

Saturday, July 9 – Presented by Walker's

8:00am – 4:00pm	Practice bays available
8:00am – 5:00pm	Check-In & Registration
9:00am	Morning Schedule Slots Begin
1:00pm	Afternoon Schedule Slots Begin

Sunday, July 10 – Presented by Tippmann Arms

8:00am – 4:00pm	Practice bays available
8:00am – 5:00pm	Check-In & Registration
9:00am	Morning Schedule Slots Begin
1:00pm	Afternoon Schedule Slots Begin

Monday, July 11 – Presented by TK & Next Level Training

8:00am – 4:00pm	Practice bays available
8:00am – 5:00pm	Check-In & Registration
9:00am	Morning Schedule Slots Begin
1:00pm	Afternoon Schedule Slots Begin

Tuesday, July 12 – Presented by GLOCK

8:00am – 4:00pm	Practice bays available
8:00am – 5:00pm	Check-In & Registration
9:00am	Morning Schedule Slots Begin
10:00am	Shane Coley, GLOCK Pro Shooting Clinic - Action shooting berm
12:00pm	Shane Coley to shoot SASP stages
3:00pm	Shane Coley, GLOCK Pro Shooting Clinic - Action shooting berm
1:00pm	Afternoon Schedule Slots Begin

Wednesday, July 13 – Presented by MidwayUSA Foundation: Jack Fishburn Day

8:00am – 4:00pm	Practice bays available
8:00am – 5:00pm	Check-In & Registration
9:00am	Morning Schedule Slots Begin
1:00pm	Afternoon Schedule Slots Begin
5:30pm	All Industry Opening Ceremonies, States/Teams parade – Grandstands

Thursday, July 14 – Presented by Beretta, Hoppe's, and Champion Target

8:00am – 4:00pm	Practice bays available
8:00am – 5:00pm	Check-In & Registration
9:00am	Morning Schedule Slots Begin
1:00pm	Afternoon Schedule Slots Begin



## Practice Bays (2)

Practice bays will be available during the week for teams to practice their skills prior to competing in the SASP match. Hours are: 8:00am to 4:00pm. Teams will need to schedule time on the practice bays. Availability is in 15-minute increments. Price is \$10 a team for 15 minutes. \*Coach supervision is required to purchase and schedule time on the practice bays and while the team practices.

## SASP NATIONALS AWARDS

### Main Event Awards

**Pistol (Centerfire Iron & Optic, Rimfire Iron & Optic, and 1911):** 1st – 3rd Each Division  
Intermediate Senior

**Rifle (Rimfire Iron & Optic, and Pistol Caliber Carbine):** 1st – 3rd Each Division  
Rookie Intermediate Senior

## SASP TRUGLO HOA AWARDS

### Main Event Awards

#### Pistol

High Overall Male & Female: 1st – 3rd  
Intermediate Entry  
Intermediate Advanced  
Senior – Junior Varsity  
Senior – Varsity

#### Rifle

High Overall Male & Female: 1st – 3rd  
Rookie  
Intermediate Entry  
Intermediate Advanced  
Senior – Junior Varsity  
Senior – Varsity

## SUMMER BLAST

Awards for collegiate athletes competing alongside their high school team

## MATCH INFORMATION & GUIDELINES

### Age Divisions:

#### Rookie Division (Rifle Only)

5th Grade and under

#### Intermediate – Entry

6th to 8th Grade (First year competing as Intermediate)

#### Intermediate – Advanced

6th to 8th Grade (Second year competing as Intermediate)

#### Senior – Junior Varsity

9th to 12th Grade (First year competing as Senior)

#### Senior – Varsity

9th to 12th Grade (Second year competing as Senior)

Eligibility ends with graduation from high school or once a student reaches his/her 20th birthday, whichever comes first.

## Pistol

### Rimfire Division

Iron Sights

Optic Sights

### Rifle

### Rimfire Division

Iron Sights

Optic Sights

### Centerfire Division

Iron Sights

Optic Sights

### 1911 Division

### Pistol Caliber Carbine

### Match Fees:

Pistol - \$55 per shooter entry | Rifle - \$55 per shooter entry

## APPEALS COMMITTEE

Tom Kilbane, Kelvin Walton, Rick Leach, Lisa Poet, Eliot Jardines



FEDERAL  PREMIUM

NEW

# HIGH OVER ALL



SKEET  
—  
SPORTING CLAYS  
—  
TRAP

**MORE HITS. MORE RELOADS. MORE WINS.**

It's here. New **FEDERAL PREMIUM® HIGH OVER ALL™** leaves a trail of shattered targets in its wake and more reloads per shell. Its hard, high-antimony lead shot and exclusive one-piece Podium™ wad produce the most consistent patterns, while the solid brass head and tapered hull make reloading easier than ever. *Victory is yours.*

- 1 SOLID BRASS HEAD
- 2 TARGET SHOTSHELL PRIMER
- 3 INTEGRAL BASE WAD AND TAPERED HULL
- 4 ONE-PIECE PODIUM WAD
- 5 HARD, HIGH-ANTIMONY LEAD PELLETS
- 6 EIGHT-SEGMENT CRIMP

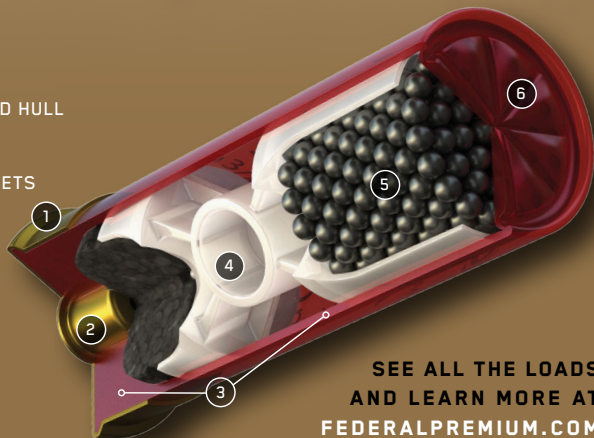

©2022 Federal Ammunition

SEE ALL THE LOADS  
AND LEARN MORE AT  
[FEDERALPREMIUM.COM](http://FEDERALPREMIUM.COM)

## CAMPING

### SCTP / SASP NATIONALS

- ALL visitors must register with the office upon arrival. Daily Fee of \$5 fee per adult and \$3 fee per child age 11 and under, which allows visitors swimming and fishing privileges.
- ALL visitors are asked to leave the grounds by 10 p.m. CURFEW is 10 p.m. for ages 17 and under. QUIET time will be observed from 11 p.m. to 8 a.m.
- ONE unit per site for a family of four (2 adults & 2 children). One additional child size tent (5 ft. sq.) is permitted. Additional guests are to pay daily rate. Limit 8 guests per site.
- PLEASE observe the posted speed limit. Watch for children and pets. Violators of this rule may be removed from competition with no refund.
- NO lifeguard on duty, do not leave children unattended.
- RECREATION, pool & shower facilities are for the sole use of paid guests.
- YOU are responsible for your children and those of your visitors. Children age 14 and under must have adult supervision while using the facilities.
- PLEASE do not cut through occupied sites.
- NO state license is required to fish in the stocked lake. Catch and release only.
- WE welcome friendly pets on leashes (do not leave unattended). Please clean up after your pets. Pets are not permitted in cabins, buildings, or pool area.
- NO fireworks of any kind are permitted on our grounds.
- CAMPFIRES in fire rings only. ONE fire ring and picnic table per site. DO NOT remove the fire rings or tables. NO portable grills on picnic tables.
- NO dumping of gray water on any part of the grounds.
- GOLF CARTS must be driven by licensed drivers only, with proof of insurance; and may only be driven on roads and golf cart paths.
- NO ATVs, mini-bikes, motorized scooters, or dirt bikes may be used to drive about the grounds. NO bicycles after dusk.
- ONLY 2 vehicles per site. Utility trailers, boats and extra vehicles may be parked in storage area for \$35 per month.
- NO mail delivery on the grounds – please rent a P.O. Box in Marengo. Also no personal messages delivered to sites.
- PLEASE keep park clean; place trash in dumpsters or receptacles. Cutting of trees or shrubbery is prohibited.
- NO outside refrigerators, washers, or dryers permitted.
- WASHING of campers/RVs is not permitted (please use Sparkle 'n Shine Car Wash, featuring an outdoor RV bay).
- NO alcohol permitted in recreational buildings, in the pool, or on golf carts. Drunken or rowdy behavior will not be tolerated.
- UNRULY guests will be asked to leave the premises.

*We reserve the right to discharge any persons, without refund, for failure to abide by any of the campground rules or guidelines. Please notify the office, or a staff member, of any inappropriate behavior.*



FABBRICA ARMI ISIDORO RIZZINI

# FOSSARI® SHOTGUNS

AMERICAN VALUE MEETS  
ITALIAN STYLE AND QUALITY



FOSSARI® SPORTING

FOSSARI® SPORTING BSR



ITALIAN FIREARMS  
GROUP

IFG-USA.COM

## AMMUNITION

Ammunition will be available at Sportsman's Den and the SCTP/SASP Store. All shooters are responsible for their own ammunition. The Ammunition Building will be open from 8am to 6pm daily.

## GOLF CART AND UTV RULES

- GOLF CARTS and UTVs/SIDE BY SIDES must be driven by licensed drivers only, with proof of insurance; and may only be driven on roads and golf cart paths.
- NO ATVs, mini-bikes, motorized scooters, or dirt bikes may be used to drive about the grounds. NO bicycles after dusk.
- Posted speed limits must be observed.

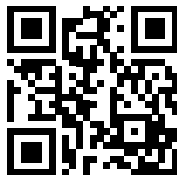

For complete campground and facility rules, go to: <http://bit.ly/1X6SFO9> (or scan QR code).

## GOLF CART RENTALS

All of the golf car rentals at Cardinal Center are handled by Eagle Golf Cars. If you are interested in renting a golf car, contact them at: 888-432-3059 | [eaglegolfcars@aol.com](mailto:eaglegolfcars@aol.com) | [eaglegolfcars.net](http://eaglegolfcars.net)

## DIRECTIONS

Cardinal Shooting Center | 616 State Rt. 61 | Marengo, OH 43334

From Columbus: Take I-71N 29 miles to exit 140 toward Mt. Gilead/Galion. Exit I-71, then take a left on OH-61 north. Go 0.5 miles on OH-61 and enter the facility on the left via Cardinal Drive.

From Cleveland: Take I-71S for 110 miles to exit 140 toward Sunbury/Mt. Gilead. After exiting I-71 take a right on OH-61 north. Go 0.5 mile on OH-61 and enter the facility on the left via Cardinal Drive.



**Hunter's Blend, the official coffee of the SCTP, is offering 10% donated back to SCTP Scholarship Fund on purchases of regularly priced products when using this link:**

**[huntersblendcoffee.com/discount/SCTP](http://huntersblendcoffee.com/discount/SCTP)**



**Come see us at the 2022 SCTP National Event  
The BOSS Mobile Showroom Will Be Located Between  
Vendor Buildings 1 & 2**

**BLU**  **BLACK**  
**DIAMOND**

  
**PILLA**  
BY PERFORMANCE OPTICS

  
**SYREN**

  
**negrini**  
made in italy

**CÆSAR**  
**GUERINI**

 **BROWNING**

 **FABARM**

**Demo Guns will be available!!!**

**SCTP Athlete discount on Pilla Performance Eyeware**

  
**Bettinsoli**  
U S A

Proud partners with Bettinsoli USA for the  
“Skeet Doubles Competition”.  
One lucky athlete will win a  
Bettinsoli Omega Sport

Join us for “Pizza Night” at the Main Pavilion behind the grandstands...  
We will be there serving over 600 pizzas!

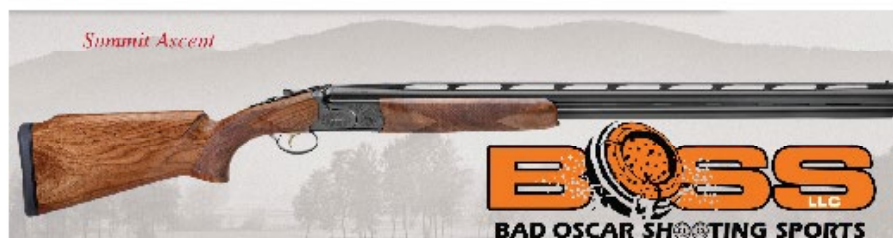

**Fine Firearms & Shooting Sports Accessories For  
The Clay Target & Wing Shooting Enthusiast**

**[www.badoscarshootingports.com](http://www.badoscarshootingports.com)**

**Proud Sponsor of the SCTP National Program**

## ADDITIONAL GUIDELINES FOR SCTP & SASP:

1. Current ATA, NSCA, NSSA, USA Shooting and SASP rules, as well as rules in this program and any match or National Director's bulletins posted on this range, govern this match.
2. All participating athletes and coaches must be registered and fully paid with the SSSF before competing. Event registrations are accepted on a first-come, first-served basis. For SCTP and SASP, all reservations will be done electronically through the team login at [www.sssfonline.org](http://www.sssfonline.org).
3. All ammunition and practice rounds are the responsibility of the participant.
4. Alcohol/illegal or individually non-prescribed drugs and firearms do not mix. Alcohol and other illegal substances are strictly forbidden by the SSSF during this event. Further, any person who is found to be in possession of, or under the influence of, alcohol or drugs while using, cleaning, maintaining, inspecting, or otherwise handling their shotgun or any other firearm at any time will be immediately disqualified from the entire event and asked to leave without refund.
5. Safe gun handling and appropriate shooting attire are required. Flip-flops and open-toed shoes are prohibited. No tank tops, mid-drift tops or shorts above mid-thigh are allowed.

Reprimands will be issued based on violation and could ultimately mean disqualification from the tournament.

6. **Hat shooting is strictly prohibited during competition.** Once all competition has been completed, hat shooting may occur 1) ONLY after receiving permission from the tournament director or staff member and 2) under the supervision of a state advisor or coach. Any competitor who participates in hat shooting outside of both of these conditions will be immediately disqualified and asked to leave the competition without refund.
7. All shooters must sign the score sheet (next to the score total) before leaving the range.
8. Use of any tobacco product by anyone under the age of 18 is against Ohio State Law, and any use of tobacco product by an SCTP/SASP participant under the age of 18 is against SSSF guidelines. Participating in the use of tobacco products can be grounds for disqualification from the tournament.
9. Any athlete or adult disqualified from the tournament will not receive a refund of any tournament fees, game fees, practice fees or any other funds paid to SSSF or its agents.
10. 1st-5th place ties in the Individual Skeet & Trap events will be broken by long run back



**WORLD'S BEST TRAPS**

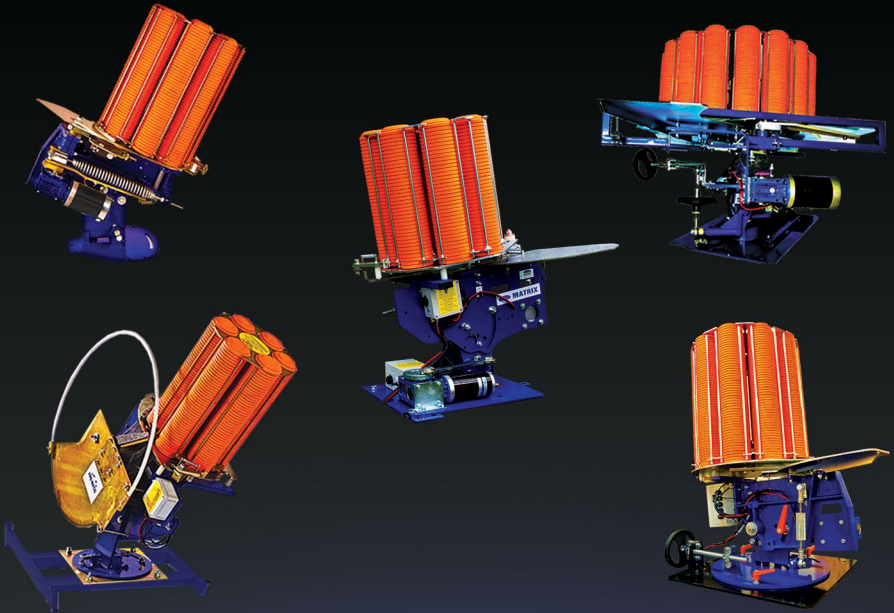

***PROUD TO SPONSOR THE SCTP***  
**SKEET | TRAP | SPORTING | OLYMPIC**

**888.767.2529 | WWW.PROMATIC.BIZ**  
**FOR THE DEALER NEAREST YOU**



**nsi**  
NOBELSPORTITALIA



*Talent Hits Targets...*



*Believe  
Achieve*







**WE'RE PROUD TO  
SUPPORT THE SCHOLASTIC  
CLAY TARGET PROGRAM,  
AS PART OF OUR  
COMMITMENT TO THE FUTURE  
OF SHOOTING SPORTS.**

**Mossberg— Makers of  
dependable, hardworking firearms  
for more than a century.**

**SAFETY TIP** 

Store firearms securely, inaccessible  
to children and unauthorized users.

**MOSSBERG**<sup>®</sup>  
SINCE 1919



# 2022 PROGRAM SPONSORS

## BENEFACTOR



CHANGING THE FUTURE OF  
YOUTH SHOOTING SPORTS

## FOUNDING SPONSOR



## PARTNERS



## RED DIAMOND SPONSORS



## TITANIUM SPONSORS



## PLATINUM



GOLD SPONSORS



SILVER SPONSORS



BRONZE SPONSORS



COPPER SPONSORS



BRASS SPONSORS



MEMBER SPONSORS

Americase, Bob Palmer, Cedar Valley Cheese, Crown Awards, Klement's Sausage, Pizza Hut, Quality Seafood, Rite in Rain, Shooting USA, TenPoint Crossbows, BulkMunitions



HUNTERS HD  
GOLD

They CHANGE so you don't have to.



# The Great outdoors Company, Inc.

BUILDINGS B-11 & B-12



**SCTP/SASP GIFT SHOP**

**NATIONALS T-SHIRTS**

**CARDINAL GIFT SHOP**

• **CARDINAL LOGO MERCHANDISE**

**CROCS**

**UNDERARMOUR**

**SHOOTING GIFTS**

**DRAKE SHOOTING SHIRTS**

**LONESOME CHARLIE LEATHER GOODS**





**FIOCCHI**®



**MADE FOR SHOOTERS...  
BY SHOOTERS**

FIOCCHIUSA.COM     @FIOCCHIUSA



# 2022 PROGRAM SPONSORS

## BENEFACTOR



CHANGING THE FUTURE OF  
YOUTH SHOOTING SPORTS

## FOUNDING & SUSTAINING SPONSORS



## PLATINUM SPONSORS



## GOLD SPONSORS



SILVER SPONSORS



BRONZE SPONSORS



PARTNERS





**TIPPMANN  
ARMS™**

# M4-22 SASP EDITION

Semi-Automatic  
.22LR Caliber  
Laser Engraved Lower  
6 Magazines  
Aluminum Upper & Lower  
Fluted Barrel  
Thread Cap  
Forward Assist  
Dust Cover  
Bolt Catch



A portion of proceeds go towards the  
SASP Scholarship Fund.



[www.TippmannArms.com](http://www.TippmannArms.com) | 844 340 9317



Remington®

Remington  
**TRAINING OR  
COMPETING.  
TRUST REMINGTON.**

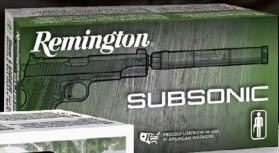

Another range day or the match day you've been waiting for, Remington's quality ammunition always gets the job done. For generations, coaches and champions have trusted Remington ammo.



**PROUDLY MADE IN THE USA  
BY AMERICAN WORKERS**

© 2021 Remington Ammunition. Remington and UMC are registered trademarks of Remington Ammunition.

[WWW.REMINGTON.COM](http://WWW.REMINGTON.COM)



## 2022 SASP NATIONAL CHAMPIONSHIP

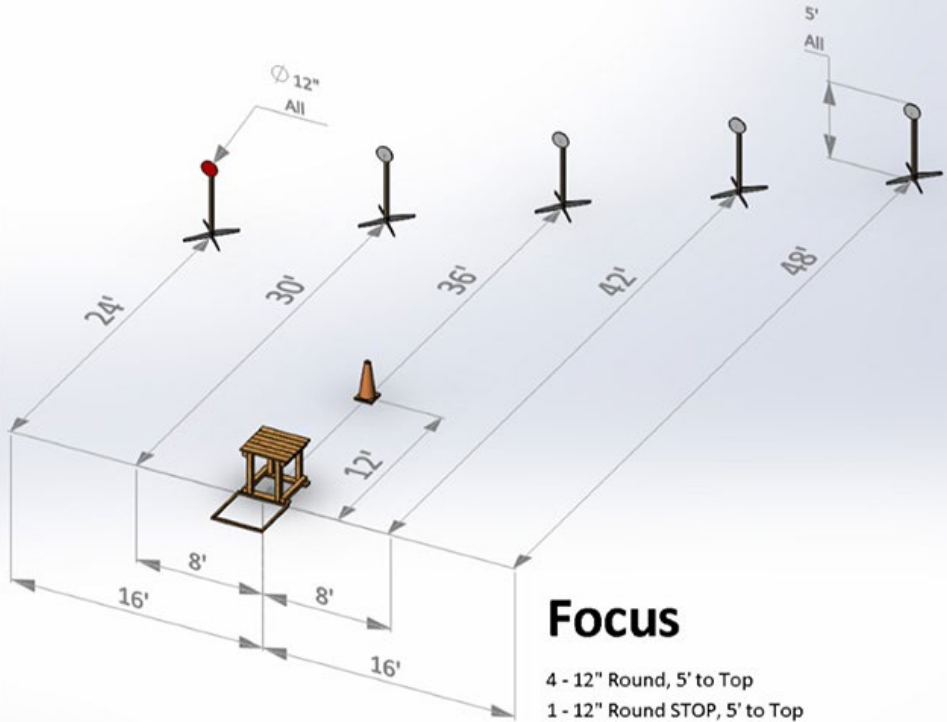

All target heights are approximate due to the type of surface that they are set on; there may be slight differences in height. Please try to be consistent or use our Founding Partner, Action 1 target's PT Static Targets, which are SASP approved for all stages.

**SPONSORED BY:**



# DONATE TO YOUTH SHOOTING SPORTS TEAMS EVERYWHERE WITH THE SSSF.



**READY TO GIVE A GIFT?  
LET'S GET STARTED!**

**SSSFONLINE.ORG/DONATE**



**SSSF**  
SCHOLASTIC  
SHOOTING SPORTS  
FOUNDATION

IRA - STOCKS - MUTUAL FUNDS - DONOR ADVISED FUND

# 2022 SASP NATIONAL CHAMPIONSHIP STAGES

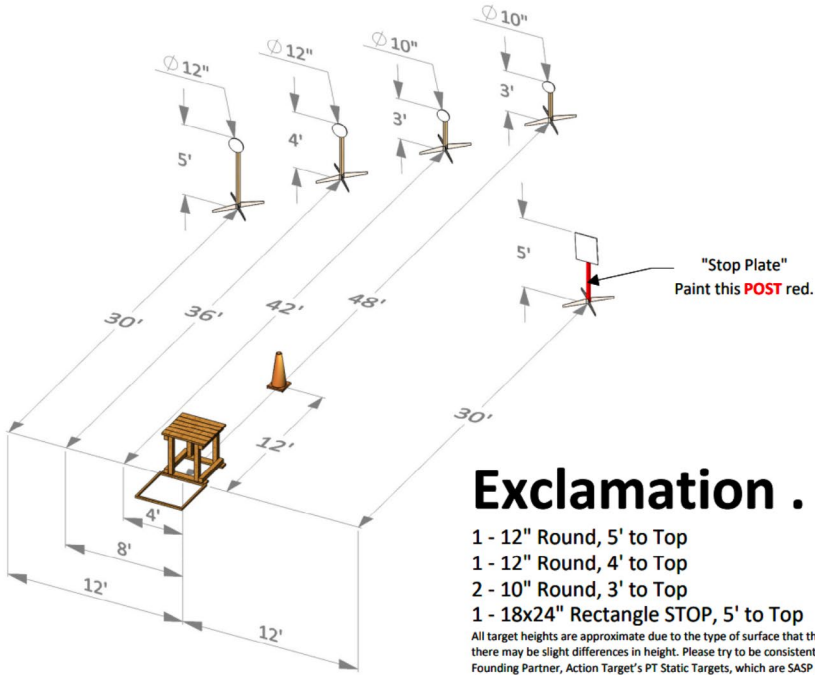

## Exclamation .

- 1 - 12" Round, 5' to Top
- 1 - 12" Round, 4' to Top
- 2 - 10" Round, 3' to Top
- 1 - 18x24" Rectangle STOP, 5' to Top

All target heights are approximate due to the type of surface that they are set on; there may be slight differences in height. Please try to be consistent or use our Founding Partner, Action Target's PT Static Targets, which are SASP approved for all stages.

**SPONSORED BY:**





# PROTECT & MAINTAIN

CLAY TARGET  
THROWERS

FIREARM  
MAINTENANCE

SHOOTING  
ACCESSORIES

METAL  
FINISHING

WOOD  
FINISHING

FIREARM  
CASES

UNIVERSAL  
CLEANING KITS

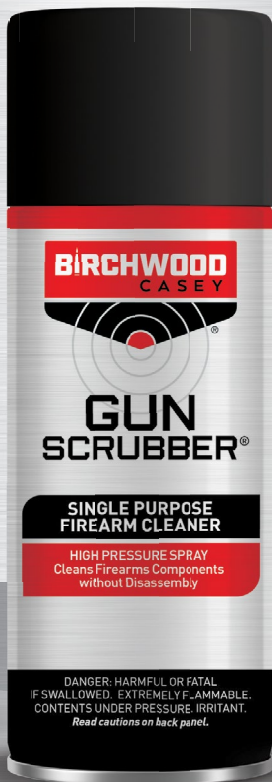

Since 1948, serious shooters, avid collectors and professional gunsmiths have relied on Birchwood Casey for shooting and gun care products that have stood the test of time. From legendary Tru-Oil® Gun Stock Finish and Perma Blue® Liquid Gun Blue to revolutionary Shoot•N•C® Targets, Birchwood Casey has pioneered innovative products with an unwavering dedication for quality.



# 2022 SASP NATIONAL CHAMPIONSHIP STAGES

## Go Fast!

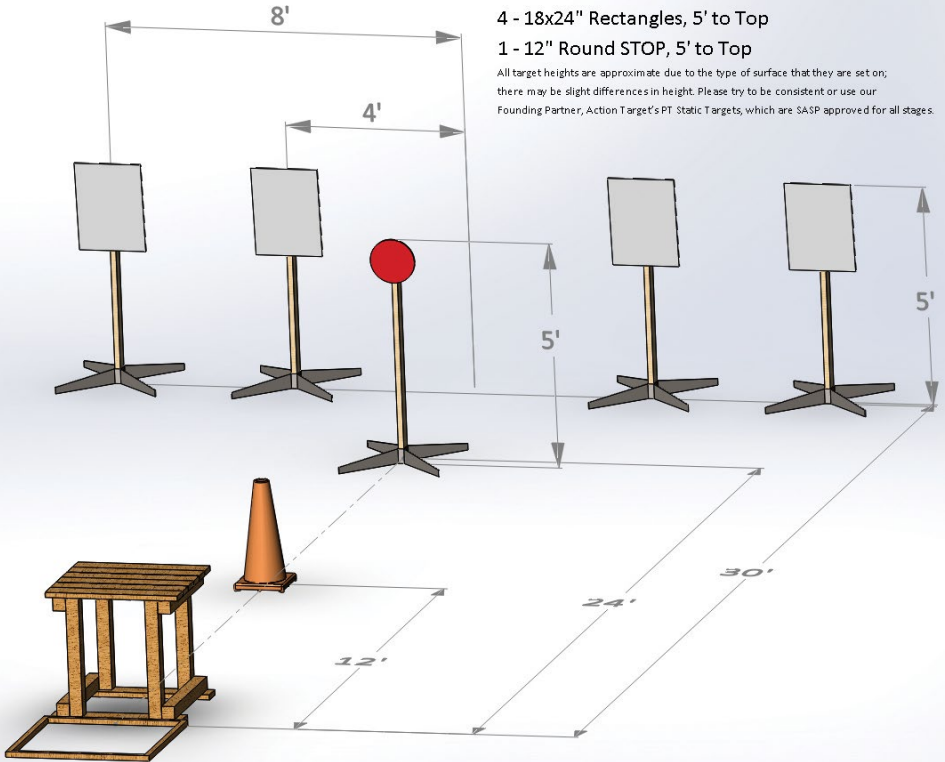

**SPONSORED BY:**

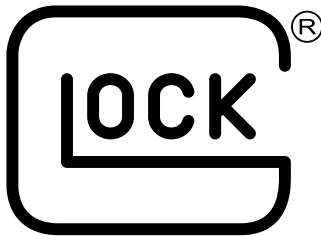

**PERFECTION**

**In life, as in shotgunning,  
the big breaks are  
often the result of  
leading successfully.**



**Best of luck and congratulations to all of our  
future leaders at the 2022 SCTP Nationals**



**B R I L E Y**  
*A Legacy of Shooting Innovation.*





## 2022 SASP NATIONAL CHAMPIONSHIP

### V For V (5 For 5)

2 - 10" Round, 4' to Top

2 - 12" Round, 3' to Top

1 - 12" STOP, 5' to Top

All target heights are approximate due to the type of surface that they are set on; there may be slight differences in height. Please try to be consistent or use our Founding Partner, Action Target's PT Static Targets, which are SASP approved for all stages.

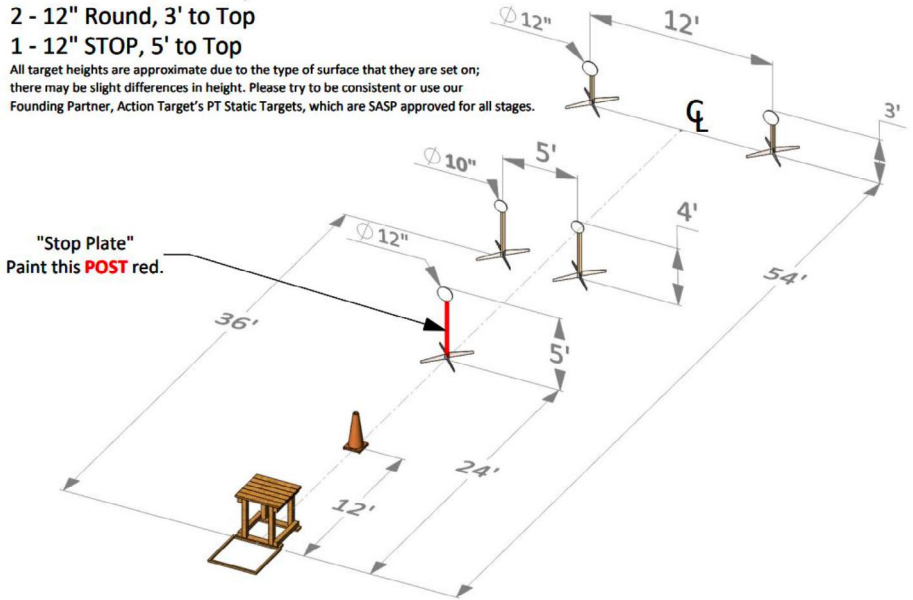

**SPONSORED BY:**







**LENA MICULEK**  
 Pro Shooter  
 Team SIG

**SIG SAUER**  
 NEVER SETTLE

sigsauer.com

**CZ-USA**  
 PROTECT • HONOR • COMBATE

**P-10**



**RUGGED + RELIABLE + OPTIC READY**

Taking the striker-fired category by storm, the CZ P-10 delivers what most in the genre can't. From the superb trigger to the purpose-driven features to the engineered ergonomics – the P-10 is the complete package, right out of the box. With 12+1 capacity in the P-10 S, 15+1 in the P-10 C and 19+1 in the P-10 F, there's a P-10 for every purpose.

**CZ-USA.COM**

**Swab/its®**

Firearm Cleaning Products

**Clean your Firearm  
 SAFE - EASY - FUN**



Bore-tips®

Star Chamber  
 Cleaner™

Bore-Whips®

Gun-tips®

[www.swab-its.com](http://www.swab-its.com)

Swab-its, Bore-tips, and Gun-tips are registered trademarks of Super Brush LLC  
 Bore-Whips is a trademarks of Super Brush LLC



**PA PRIMARY ARMS**

**SUPERIOR SERVICE,  
 FAST SHIPPING**  
 YOUR ONE STOP SHOP FOR  
 FIREARMS AND ACCESSORIES

**SHOP NOW  
 PRIMARYARMS.COM**

[TANDEMKROSS]

# MAKING GOOD GUNS GREAT!

SINCE 2012

Performance parts and accessories for firearms offered at great prices with unbeatable customer service.

WE DON'T MAKE CHAMPIONS.  
THEY JUST USE OUR PARTS.



Team [TK] Competitor:  
"PINEAPPLE SHOOTER"  
RAEGAN HEARN

Fully assembled, competition-ready, metallic  
"Kraken" Lower for Ruger® Mark IV™ & 22/45™

[www.TANDEMKROSS.com](http://www.TANDEMKROSS.com)

MADE IN THE USA 



**MIDWAY** USA  
Midway Foundation



**SCAVENGER**  
**HUNT**

JUST A \$20 DONATION GIVES YOU THE CHANCE TO  
JOIN THE FUN AND WIN GREAT PRIZES!

**GET STARTED!**

FIND A MIDWAYUSA FOUNDATION STAFF MEMBER  
BEHIND THE CENTRAL ENTRY BUILDING!



SHARE PHOTOS OF YOUR HUNT &  
TAG @MIDWAYUSAF FOUNDATION



# Proud to win it...



With nearly 50 years in the shooting industry,  
let us customize a trophy package for your next shoot.



# Proud to own it...

Range Bags  
Shell Pouches  
Awards  
Accessories



# Proud to pass it on.



National Sponsor

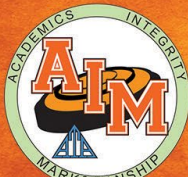

National Sponsor



National Championship Sponsor



800.728.5184 • [ShamrockLeathers.com](http://ShamrockLeathers.com) • [Contact@ShamrockLeathers.com](mailto:Contact@ShamrockLeathers.com)

# SOCIAL MEDIA



Tag your social media posts and photos with

#SCTPNationals2022

#SASPNationals2022



Instagram: @mysctp



Instagram: @my\_sasp

FAST. ACCURATE.  
**BRIGHT AS HELL.**

**FIBER-OPTIC PRO**

COMPETITION GRADE PISTOL SIGHTS



**PATENTED LIGHT REFLECTOR**

Directs available light into the fiber for 360° illumination, making our industry-leading fiber even brighter.

**AVAILABLE FOR:**

Glock®  
CZ® P10  
Smith & Wesson® M&P®  
Springfield Armory® XD  
CZ® Shadow 1 & 2\*  
Sig® X5\*  
Walther® Q5 & Q5 SF\*

NEW  
NEW  
NEW

**EXTRA FIBER INCLUDED!**

Change colors or replace as needed. (0.050" Diameter)



**TRUGLO**  
**TACTICAL**

\*Front sight only, to be used with factory adjustable rear sight

# CONGRATULATIONS TO THE 2022 SSSF ALL-SCHOLASTIC TEAM!

These exceptional student athletes are named to the team in recognition of their excellence in shooting, academics and community involvement.

## SCHOLASTIC CLAY TARGET & SCHOLASTIC ACTION SHOOTING PROGRAM

Adam	Glenn	AL	Parker	Ellington	GA	Jackson	Schroder	MI
Maggie	Mizelle	AL	John	Oliver	GA	Gage	Maxson	Mi
Stephen	Hendrix	AZ	Aaron	Walker	GA	Blake	Carlson	MI
Jack	Gillmore	AZ	Maddie	Mahaney	GA	Lincoln	Martin	MI
Alexis	Fernan	AZ	Samantha	Kelchen	IA	Brandon	Grzadzinski	MI
Ian	Imrich	AZ	Matthew	Eilers	IA	Maya	Grzadzinski	MI
Alex	Imrich	AZ	Addison	McGehearty	IA	Bodi	Foulke	MI
Ethan	Espinosa	AZ	Cole	Henning	IA	Hunter	Anderson	MI
Isaiah	Magana	AZ	Lexi	Henning	IA	Gabriel	May	MI
Joshua	Wilcox	CA	Nathan	Romans	IA	Larissa	Seiler	MI
Tyler`	Cassara	CA	Aiden	Deitering	IA	Charlie	Stone	MO
Zack	Knorr	CA	Jenna	Smith	IA	Andrew	Herbig	MO
Nathan	Kosmatka	CA	Stewart	Hodge	IA	Colton	McKinney	MO
Mason	Reynolds	CA	Michael	Lemburg	IA	Ellie	Schweizer	MO
Michael	Silfies	CA	Bennett	Teitle	IA	Bradley	Phillips	MO
Wyatt	Quick	CA	Elizabeth	Faust	IA	Adam	Slade	MO
Lucas	Colombo	CA	Oscar	Olsen	IA	Joseph	Groppe	MO
Shane	Gillis	CO	Logan	Sease	IA	Tyler	Burton	MO
Liam	Watson	CO	Morgan	Hodge	IA	Thomas	Burton	MO
Coyle	Hagerty	CO	Robbie	Curtis	IA	Pete	Wann	MO
Jake	Carnie	CO	Carson	Finney	IA	Ian	Kutilek	MO
Tyler	Rotunno	CO	Brooke	O'Connor	IA	Marin	McKinney	MO
Henry	Butler	CT	Haley	Starmer	IA	Brendan	Palmisano	MO
Ava	Shelly	FL	Maddie	Caston	IA	Tucker	Carpenter	MT
Abbey	Wigh	FL	Erin	Mathes	IA	Gracie	Shoaf	NC
Drew	Fleener	FL	John	Kruse	IA	Wyatt	Shoaf	NC
Brendan	Lam	FL	Kaelan	Smith	IA	Luke	Bower	NM
Lia	Nelson	FL	Josiah	Day	IA	Chase	Dobranski	NM
Trace	Scuderi	FL	Sydney	Vavroch	IA	Vanessa	Donato	OH
Knightly	Duris	FL	Alexander	Megggers	IA	Lillian	West	OH
Jesse	Grant	FL	Gavin	Sosa	IA	Glenn	Bonham	OH
Josiah	Godbold	FL	Landon	Sievers	IL	Noah	Reeves	OH
Evan	Heit	GA	Grant	Rednour	IL	Emily	Kuhar	OH
Eric	Heit	GA	Carson	Sievers	IL	Justin	Monroe	Oh
Drake	Cooper	GA	Walker	Sibley	IL	Chandler	Cox	OH
Ayden	McKenzie	GA	Wyatt	Sibley	IL	Austin	Krahe	OH
Jake	Summerford	GA	Logan	Lawton	IL	Isaiah	Cornick	OH
Owen	Haas	GA	Alexander	Ziegler	IL	Jake	Krahe	OH
Samuel	Keuller	GA	Conor	DeZell	IL	Lilly	Herr	OH
Charlie	Spruill	GA	Benjamin	Warwick	IL	Kaylee	Joseph	OH
Dylan	Thompson	GA	Logan	Rensing	IL	Max	Hatfield	OH
Will	Morrison	GA	Ty	Leach	IL	Blaine	Simpson	OH
Zachary	McRae	GA	Ethan	Cheek	IL	Ethan	May	OH
Michael	McIntosh	GA	Ethan	Buck	IN	Aaron	Simpson	OH
Ben	Karcher	GA	Alexander	New	IN	Tyler	James	OH
William	Anderson	GA	Carter	Rudolph	IN	Cassidy	James	OH
Will	Bryant	GA	Dominick	Neal	IN	Alexis	Fisher	OH
Jakob	Duke	GA	Jimmy	Amrhein	KY	Morgan	Banks	OH
Ava	Cauley	GA	Roman	Barrett	MA	Travis	Rosendaul	OH
Noah	West	GA	Michael	Ings	MA	Ethan	Hill	OK
Mitchell	Inthirathvongsy	GA	Maxon	Versluys	MI	Zak	Sutton	PA

# SSSF

SCHOLASTIC  
SHOOTING SPORTS  
FOUNDATION

Braeden Fisher PA	Sawyer Phipps TN	Brayden Hoppa WI
Gavin Glossner PA	Logan Glass TN	Alex Bush WI
Dalton Prevost PA	Claira Grace Russell TN	Brendan Becker WI
Donald Miller PA	Logan Martinez TX	Jacob Meister WI
Samuel Klinepeter PA	Owen Schlegel TX	Michael Arnett WI
Mason Mentzer PA	Ethan Domke TX	Zander Rasmussen WI
Grant Glossner PA	Owen Lyons TX	Eli Watral WI
Katelyn Henry PA	Brady Laramie TX	Kyle Polster WI
Brayden Clarke PA	Wes Roddie TX	Riley Cammers WI
Jacob Holmes PA	Allison Hayes TX	Daniel Serra WI
Kayla Wood PA	Brett Chasteen TX	Trevor Polster WI
Ann Blankenship SC	Hunter Green TX	Trenton Giese WI
Turner Parcell SC	Samantha Srodulski TX	Izabel Downs WI
Gage Yarborough SC	Ruby Daily TX	Tori Cychosz WI
Jeffrey Stone SC	Dylan Little TX	Ty Petersen WI
Zachary Bererman SC	Scott Mason TX	Taylor Dale WI
Noah Crair SC	Christoff Aguila TX	Brianna Giese WI
Charlie Bobo SC	Coy Losawyer TX	Samuel Cyganiak WI
Thomas Dinnen SC	Brandon Martin TX	Cole Burns WI
George Bobo SC	Conner Harrington TX	Sydney Farm WI
Megan Steves SC	Hayden Bolbock TX	Blake Conant WI
Sly Wood SC	Nethaniel Menchaca TX	Angie Wolfert WI
Gabe Reinhardt SC	Randy Gaytan TX	Ava Downs WI
Ryan Bright SC	Landon Treague TX	Tucker Schuerman WI
Caroline Cashion TN	Rico Gaytan TX	Gehrig Grenawalt WI
Maleah Epley TN	Cole Cullens TX	Jesse Nau WI
Harrison Hicks TN	Alyson Battreall TX	Elliot Iczkowski WI
Cody Hinton TN	Lucas Bland TX	Edyn Marx WI
John Campbell TN	Cody Little Jr. TX	Eyan Marx WI
John Crutcher TN	Mason Byrd TX	Courtney Wolfert WI
Zachary Morgan TN	Gabriella Erb TX	Samantha Tuchscherer WI
Bastian Botha TN	Olivia Albertson TX	Lauren Kern WI
John Wright TN	Harris Thomas TX	Dylan Joel WI
Johnathon Savage TN	Connor Rezykowski TX	Sydney Young WI
Lily Pearl Demastus TN	Zachary Michael TX	Wyatt Young WI
Hayden Demastus TN	Tally-King Miranda TX	Savanna Gallagher WI
Robert Angell TN	David Whipp III VA	Aubrey Young WI
Hannah Demastus TN	Samantha McInteer VA	Corey Hurda WI
Ashley Sellers TN	Alex Baird VA	Tommy Hurda WI
Zoie Clark TN	Mackenzie Gilkison VA	Emily Bush WI
Hunter Raley TN	Maccoy Gilkison VA	Connor Knapp WI
Allie Watson TN	Jackson Wade VA	Kimberly Rosner WI
Christian Wagner TN	Andrew Sullivan VA	Taylor Baldewicz WI
Chloe Pemberton TN	Aidan Morlock VA	Tyler Knaebe WI
Wyatt Freels TN	Brady Kern WI	Kelsey Kobus WI
Will Gardner TN	Brennan Kind WI	Stella Young WI
Alex Lacina TN	Matthew Smith WI	Abby Jackley WI
Hunter Burgess TN	Noah Lehnert WI	Sadie Richter WI
Kade Forsythe TN	Nathan Stuart WI	cody miller WI
Isaiah Weakley TN	Megan LaRose WI	Cori Gordon WY
Tyler Haney TN	Jacob Stolz WI	

- Approved by the ISSF
- Target of choice for the USA Olympic Training Center
- Official Target for SASP
- Official Target for NCAA

### Available versions for:

- Personal Use
- Mobile Range
- Clubs
- Large Range Installations
- Military and Lawenforcement Training Facilities
- Available for Air, Small and Full Bore Guns
- Systems for Short and Long Distance Shooting
- 3 position rifle
- Systems allowing use with air and small bore at variable distances
- Live Match results over the internet
- Real Time matches between remote single targets or range installations

Megalink USA LLC  
8602 Temple Terrace Hwy  
Building D, Unit 21, Tampa, FL 33637

Email: [info@MegalinkUSA.com](mailto:info@MegalinkUSA.com)  
Phone: (813) 983 9839 Fax: (813)899 1110  
[www.MegalinkUSA.com](http://www.MegalinkUSA.com)



At the last Olympic Games 100 % of the medals in the semi-automatic class pistol were won with **PARDINI**



You can do it too!  
Join the Champions!

**Pardini USA LLC**

8602 Temple Terrace Hwy  
Building D, Unit 21, Tampa, FL 33637

Email: [info@PardiniGuns.com](mailto:info@PardiniGuns.com)

Phone: (813) 983 9839 Fax: (813)899 1110

[www.PardiniGuns.com](http://www.PardiniGuns.com)





**WE'RE PROUD TO  
SUPPORT THE SCHOLASTIC  
ACTION SHOOTING PROGRAM,  
AS PART OF OUR  
COMMITMENT TO THE FUTURE  
OF SHOOTING SPORTS.**

**Mossberg—Makers of  
dependable, hardworking firearms  
for more than a century.**

**SAFETY TIP** 

Store firearms securely, inaccessible  
to children and unauthorized users.

**MOSSBERG**<sup>®</sup>  
SINCE 1919

**PROUD TO BE THE OFFICIAL PRACTICE CENTER  
FOR THE 2022 SCTP NATIONAL CHAMPIONSHIPS!**

**MAKE SURE YOUR TEAM IS READY  
WITH EXTRA PRACTICE TIME.**

Trap and Skeet fields available on a first-come, first-served basis. Minimum of five shooters to a field. \$7 per round. One hour practice time limit will be enforced if other teams are waiting. Feel free to get back in line.

**BEST OF LUCK, SHOOTERS!**



TRAP • SKEET • SPORTING CLAYS • PISTOL • RIFLE • RETAIL  
TRAINING • GUNSMITHING • CORPORATE EVENTS

# SSSF

SCHOLASTIC  
SHOOTING SPORTS  
FOUNDATION

By joining the Scholastic Shooting Sports Foundation as a Supporting Member you are part of the great movement of youth development through the shooting sports!

Memberships start at as little as \$40 annually and include a membership card, Supporting Member decal and other benefits. As a special gift, new Supporting Members will receive a limited edition SSSF golf-style towel!



*Scan to join the SSSF as a Supporting Member!*



*Scan to renew your Supporting Membership!*

- DUCKS.ORG/TRAP -



DUCKS UNLIMITED!

Supports Youth Shooting Sports



**TEAM RESOURCE ASSISTANCE PROGRAM**

DU T.R.A.P. provides discounted merchandise and professionally designed marketing and fundraising materials for official youth shooting teams. DU guarantees

all net revenues earned stay with the participating team for immediate use. Take advantage of this opportunity today by visiting [www.ducks.org/TRAP](http://www.ducks.org/TRAP).

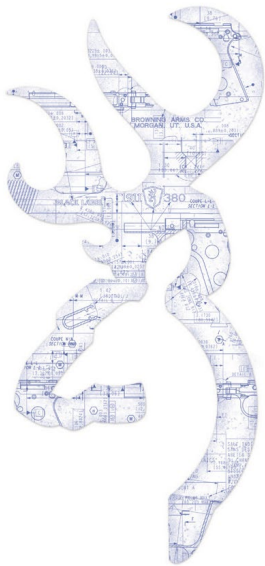

**BLUEPRINT FOR SUCCESS.**



*Black Label  
1911-380 Medallion Pro  
Full-Size*

browning.com

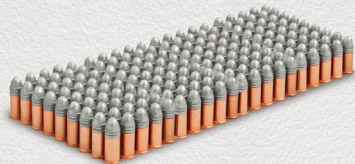

Year's Supply.

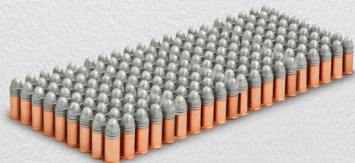

Day's Supply.

No one connects you to more firearms and accessories than GunBroker.com. Whatever kind of gun buyer you are, GunBroker.com is your kind of auction site. The world's largest online auction for every type of firearm enthusiast.



Going. Going. Gun!<sup>SM</sup>

**Cardinal  
shooting Center**



# 2022 Registered Trap Events

**Cardinal Classic**

August 16th - 21st

**Fall Freedom Classic**

September 16th - 18th

*Watch our website for pre-squad information*

[www.thecardinalcenter.com](http://www.thecardinalcenter.com)

**PRACTICE TRAP HOURS**

Wednesday-Friday 2-5 p.m. Saturday 10 a.m. - 5 p.m. Sunday 12 p.m. -5p.m.

# GUNS UNLIMITED EXCLUSIVE

## JUST ARRIVED

ADJ RIB O/U BBLS – 725 TRAP COMBO, SPECIAL SPORTING, & UNIVERSAL



### 725 ADJUSTABLE RIB TRAP COMBOS WITH HARD CASE



INCLUDES 5 EXTENDED INVECTOR DS CHOKES  
& 1 FLUSH INVECTOR DS CHOKE

30"/32"  
30"/34"  
32"/34"

**RH & LH  
AVAILABLE**

MONTE CARLO **\$5,299**

ADJ COMB **\$5,494**

ADJ COMB/GRACOIL **\$5,844**



LIMITED QUANTITIES



### CITORI SPECIAL SPORTING HI POST ADJUSTABLE RIB

12GA ONLY 30" OR 32"  
MIDAS CHOKE TUBES

FIXED **\$2,399**

ADJ COMB **\$2,594**

ADJ COMB/GRACOIL **\$2,944**



AVAILABLE NOW!



### UNIVERSAL HI POST ADJUSTABLE RIB

PARALLEL MONTE CARLO COMB

12GA ONLY 30" OR 32"  
MIDAS CHOKE TUBES

FIXED **\$2,399**

ADJ COMB **\$2,594**

ADJ COMB/GRACOIL **\$2,944**

# Guns Unlimited

4325 S. 120th Street

Omaha, NE 68137 PH 402.339.0771

FX 402.330.8029

[sales@gunsunlimitedomaha.com](mailto:sales@gunsunlimitedomaha.com)



Subject To Stock On Hand • Signed & Current FFL Required • Shipping \$35 per Gun Plus Insurance  
Shipping - CODs Add \$9 • Business & Personal Checks Held 14 Days • Certified Funds & Credit Card Orders Same Day



# STEYR airguns



**EVO electronic**



**LP50 semi-automatic**

**Some people win gold medals  
Some people just pull triggers**

**Which one are you ?**



**SPORT**

sold and serviced by  
**Pilkington Competition**  
**931-924-3400**  
**pilkguns.com**



*As the owner of the Cardinal Shooting Center, Jack Fishburn supported the Scholastic Clay Target Program and Scholastic Action Shooting Program like no other. He was very instrumental in making sure our programs had a place we could call "home".*

*We will miss him tremendously but his legacy will live on in the Cardinal Shooting Center that Jack built. Nationals is confirmed to be the biggest year yet for both programs and we know Jack would be proud.*

*"you keep bringing the kids, we will keep building it...."*

*Jack Fishburn  
1938-2021*